

Technology to Inspire Innovation

Preferred Connector Products

JAE

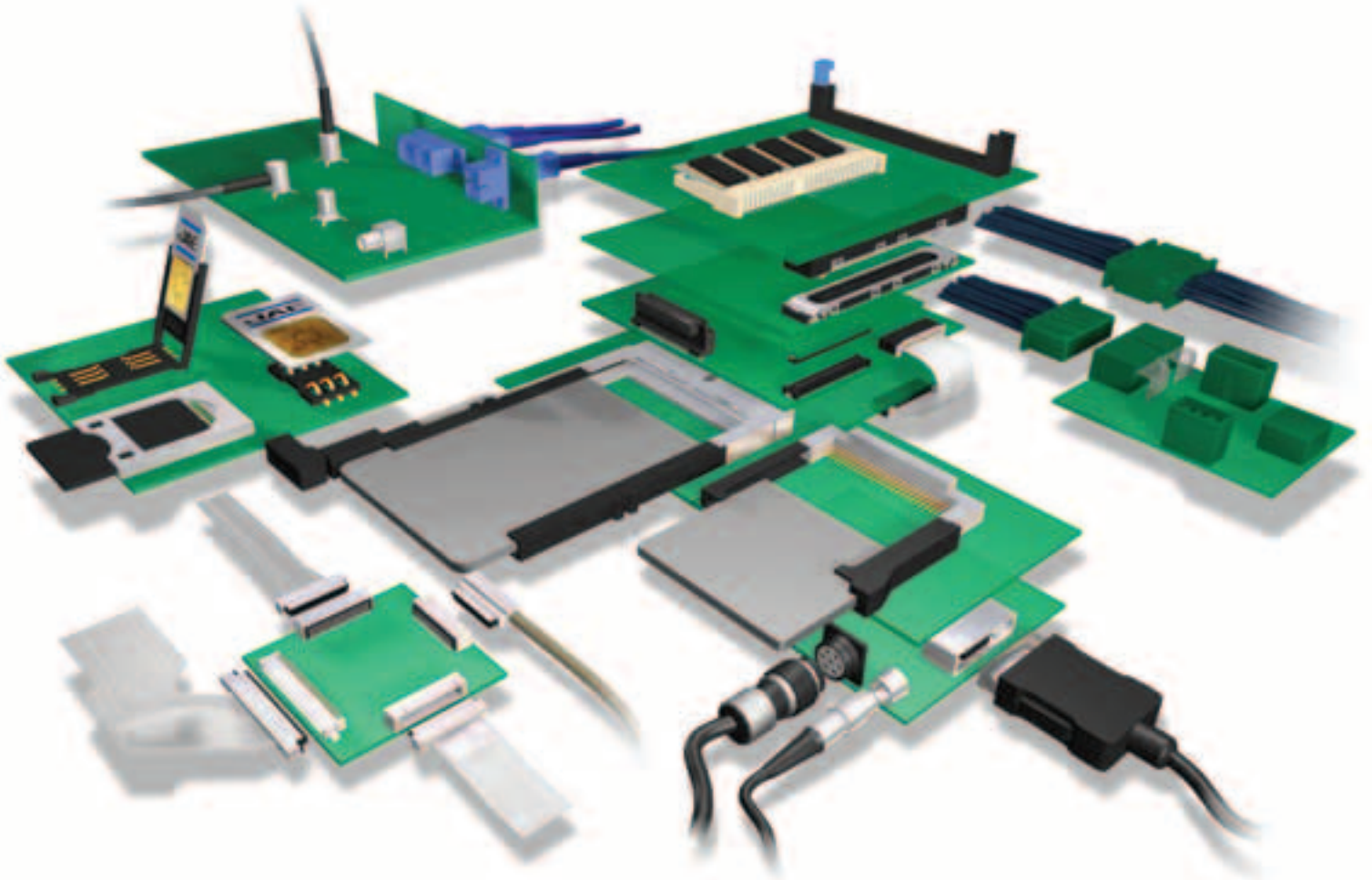

JAE Electronics, Inc.

For Additional Information Visit www.jae-connector.com

Japan Aviation Electronics Industry, Ltd. (JAE) is an international manufacturer and supplier of electronic components and systems. For over four decades, JAE has provided the electronics industry with solutions to complex design requirements. Since its founding, the Company has strived to contribute to society through market-driven, technology-based global business operations under the philosophy: "Technology to Inspire Innovation."

With worldwide and world-class manufacturing certified to ISO 9001 and QS 9000, JAE has made the commitment to meet the global requirements of our customer. In addition to a network of state of the art manufacturing facilities, JAE has technical service offices located around the world, staffed with experts in connector design and application.

This catalog contains a select overview of JAE Connector Products. For in-depth information on our complete product line, and information on new developments, visit JAE's online catalog at www.jae-connector.com.

Innovative design, quality oriented manufacturing, commitment to our customers and sensitivity to the environment assures JAE's leadership position in the 21st century.

Table of Contents

Product Series	Contact Spacing	Pages
SOCKETS/MEMORY PRODUCTS		
PCMCIA		
JC22.....	1.27mm (.050").....	5
COMPACT FLASH		
JC26C2.....	1.27mm (.050").....	6 - 7
JC26E.....	1.27mm (.050").....	8
JC26F.....	1.27mm (.050").....	9
PCI EXPRESS MINI CARD		
MM60.....	0.8mm (.031").....	10
EXPRESSCARD		
PX10/11.....	1.0mm (.039").....	11 - 12
PX20/22.....	1.0mm (.039") / 0.635mm (.025").....	13 - 14
SMART/SIM CARD		
SF2.....	2.54mm (.100").....	15
SF3.....	2.54mm (.100").....	16
SF6.....	2.54mm (.100").....	17
SF7.....	2.54mm (.100").....	18
SF7 (Slim).....	2.54mm (.100").....	19
SF9.....	2.54mm (.100").....	20
SECURE DIGITAL CARD		
SG5.....	2.50mm (.098").....	21
MINI SECURE DIGITAL CARD (SD)		
ST4.....	1.1mm (.043").....	22
SC1.....	2.50mm (.098").....	23
MICRO SD/TRANSFLASH™		
ST1.....	1.1mm (.043").....	24
ST2.....	1.1mm (.043").....	25

BOARD-TO-BOARD CONNECTOR PRODUCTS

BOARD-TO-BOARD		
AA03.....	0.40mm (.020").....	26
WA6.....	0.40mm (.020").....	27
WH1.....	0.40mm (.020").....	28
AA01A.....	0.50mm (.020").....	29
IL-312.....	0.50mm (.020").....	30
WR.....	0.50mm (.020").....	31 - 32
WB3.....	0.50mm (.020").....	33
IL-WX.....	0.80mm (.031").....	34
KX14/15.....	0.80mm (.031").....	35 - 36
PM1.....	0.80mm (.031").....	37
WM1.....	1.00mm (.039").....	38
WM2.....	1.00mm (.039").....	39
TX24/TX25.....	1.27mm (.050").....	40

Table of Contents

Product Series	Contact Spacing	Pages
BOARD-TO-BOARD CONNECTOR PRODUCTS		
WIRE-TO-BOARD		
PCB-TO-FPC/FFC		
FB3.....	0.30mm (.012").....	41
FB5.....	0.30mm (.012").....	42
FB6.....	0.30mm (.012").....	43
FF02.....	0.30mm (.012").....	44
FF02S.....	0.30mm (.012").....	45
FB8.....	0.30mm (.012").....	46
FA5.....	0.50mm (.020").....	47
FF03.....	0.50mm (.020").....	48
IL-FPR.....	0.50mm (.020").....	49
PCB-TO-CABLE/FPC		
FI-J.....	0.40mm (.016").....	50 - 51
FI-R.....	0.50mm (.020").....	52 - 53
FI-X.....	1.00mm (.039").....	54 - 55
FI.....	1.25mm (.049").....	56 - 58
PCB-TO-CABLE		
DX2/3.....	0.80mm (.031").....	59
FI-E.....	1.00mm (.039").....	60 - 61
CN10.....		62 - 63
CV10.....		64
IL-Z.....	1.25mm (.049").....	65 - 66
IL-S.....	2.00mm (.079").....	67 - 68
LY.....	2.00mm (.079").....	69
KD10/20.....	2.00mm (.079").....	70
IL-G.....	2.50mm (.098").....	71
INPUT/OUTPUT CONNECTOR PRODUCTS		
PCB-TO-CABLE		
DD1.....	0.50mm (.020").....	72 - 73
DD2.....	0.50mm (.020").....	74 - 75
DG1.....	0.50mm (.020").....	76
RA1.....	0.50mm (.020").....	77
RC1.....	0.50mm (.020").....	78
DA1.....	0.60mm (.024").....	79
DE1.....	1.27mm (.050").....	80
TX20A.....	1.27mm (.050").....	81
DV2.....	1.905mm (.075").....	82 - 84
CIRCULAR		
JN1.....		85 - 86
JN2.....		87 - 88
JB5.....		89

Table of Contents

<i>Product Series</i>	<i>Contact Spacing</i>	<i>Pages</i>
 INPUT/OUTPUT CONNECTOR PRODUCTS		
CIRCULAR		
JL04V		90 - 91
JL05		92 - 93
JB1		94 - 95
SRCN		96 - 97
N/MS		98 - 99
 FIBER OPTIC PRODUCTS		
FO-FC		100
FO-EX		101
 AUTOMOTIVE CONNECTOR PRODUCTS		
PCB-TO-CABLE		
MX34	1.1mm (.043")	102
MX7	2.30mm (.091")	103
IL-AG7	2.50mm (.098")	104
MX17	2.50mm (.098")	105 - 106
MX23A	2.50mm (.098")	107 - 108
MX10	2.50mm (.098")	109
MX5	3.00mm (.118")	110
 PCB-TO-CABLE/CABLE-TO-CABLE		
IL-AG5	2.50mm (.098")	111
IL-AG6	2.50mm (.098")	112
MX9	3.50mm (.138")	113
MX25	6.7mm (2.64")	114
MX36	2.50mm (.098")	115
 CABLE-TO-CABLE		
IL-AG9	2.50mm (.098")	116 - 118
MX19	2.50mm (.098")	119

- All JAE connector products shown in this catalog are lead free.
- We reserve the right to modify designs in order to improve quality, keep pace with technological advancements or meet particular requirements in production.
- Products shown in this catalog are made for the applications specified. However, if the above-mentioned products are to be used in aerospace devices, marine cable-connection devices, atomic power control systems, medical equipment for life-support systems, or any other specific application requiring extremely high reliability, please contact JAE for further information. Recommended Applications: Computers, Office Machines, Measuring Devices, Telecommunications Devices (Terminals, Mobile Devices) AV Devices, Household Applications, FA Devices, etc.
- Refer to end of catalog for alphabetical index of products.

IL-AG9 SERIES CONNECTORS

2.50mm (.098") Contact Spacing, Compact Relay Connector for Vehicles

1) 2 contact socket housing (IL-AG9-2S-S3C1)

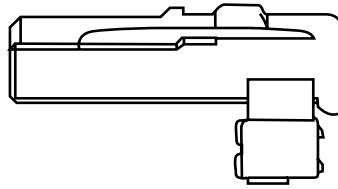
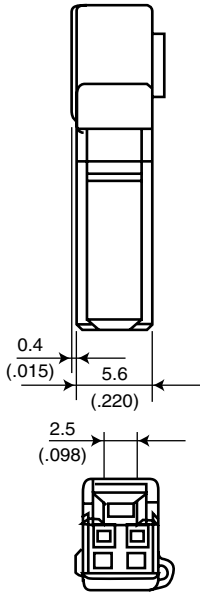

(for reference)

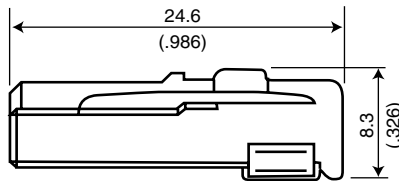

2) 2 contact relay pin housing (IL-AG9-2P-S3C1)

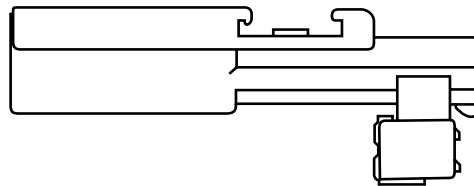
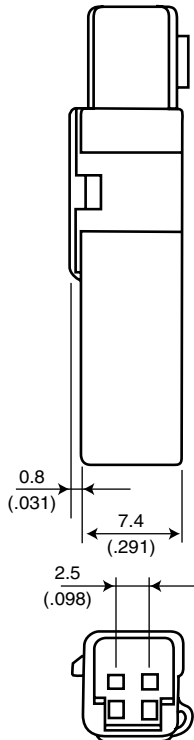

(for reference)

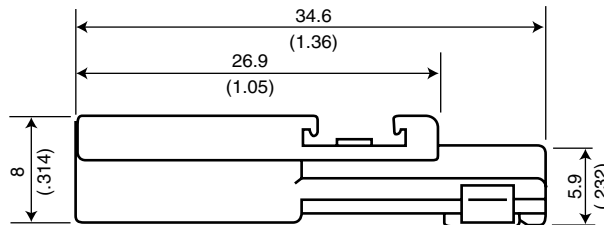

IL-AG9 SERIES CONNECTORS

2.50mm (.098") Contact Spacing, Compact Relay Connector for Vehicles

3) 3 contact socket housing (IL-AG9-3S-S3C1)

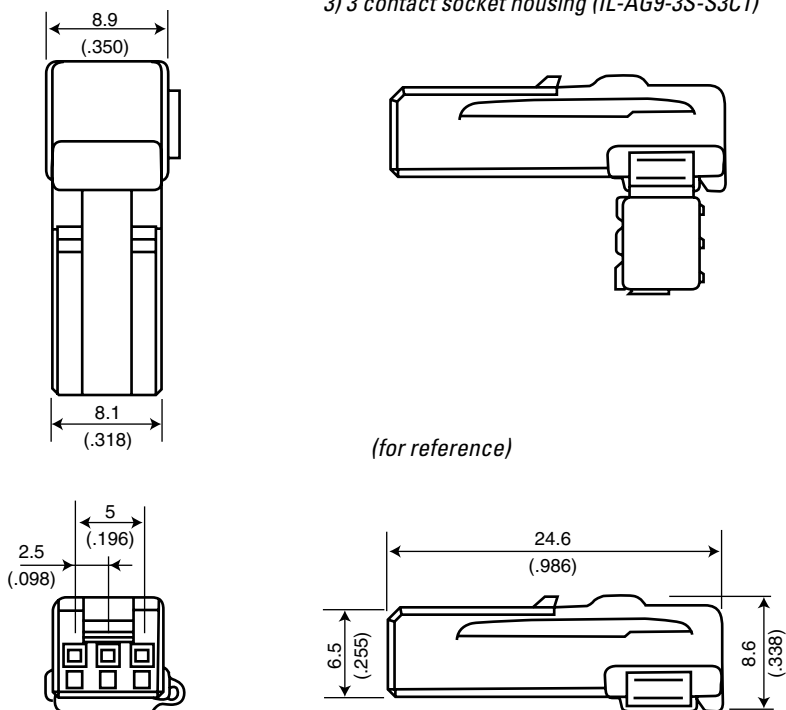

(for reference)

4) 3 contact relay pin housing (IL-AG9-3P-S3C1)

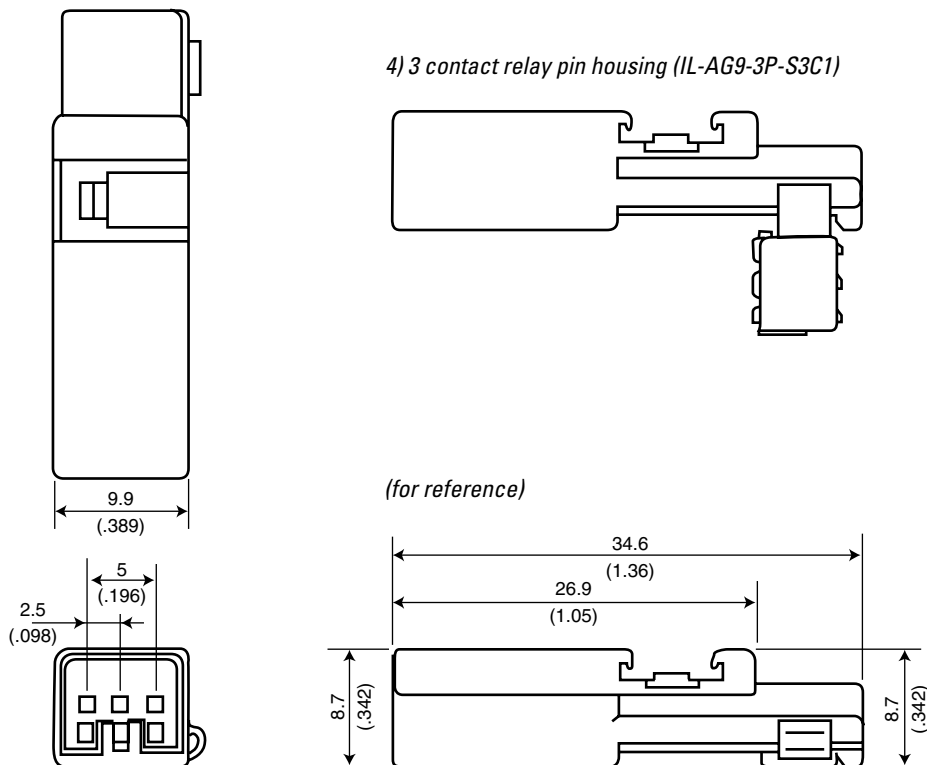

(for reference)

Technology to Inspire Innovation

JAE

***“Building Technologies
to Connect Your World”***



Japan Aviation Electronics Industry, Limited

1-19, Aobadai 3-chome, Meguro-ku
Tokyo 153-8539, Japan
Telephone: 03-3780-2736
Fax: 03-3780-2883

JAE Electronics, Inc.

142 Technology Drive, Suite 100
Irvine, California 92618-2430, U.S.A.
Telephone: 949-753-2600
Fax: 949-753-2699
800-523-7278 Toll free in the U.S.A.

JAE Europe

Coliseum Business Centre
Riverside Way, Camberley
Surrey, GU15 3YL, England
Telephone: 44-1276-404000
Fax: 44-1276-404010

JAE Taiwan, Ltd.

4F-1, No. 88, Chung Hsiao E. Rd.
Sec. 2, Taipei, Taiwan, R.O.C.
Telephone: 886-2-2396-7676
Fax: 886-2-2392-5929

JAE Hong Kong, Ltd.

Suites 1407-11, 14/F, Tower 2, The Gateway,
25 Canton Road, Tsimshatsui, Kowloon, Hong Kong
Telephone: 852-2723-7782
Fax: 852-2723-9028

JAE Korea, Inc.

1602, Korea City Air Tower
159-9 Samsung-Dong, Kangnam-ku
Seoul, 135-973, Korea
Telephone: 82-2-551-8959
Fax: 82-2-551-8958

JAE Philippines, Inc.

PEZA Zone, Gateway Business Park, Javalera
General Trias, 4107 Cavite, Philippines
Telephone: 63-46-433-0285
Fax: 63-46-433-0287

JAE Singapore Pte., Ltd.

33 Tannery Lane, #02-01 Hoesteel
Industrial Building
Singapore 347789
Telephone: 65-6748-1332
Fax: 65-6748-2920

JAE Shanghai Co., Ltd.

RM 1407, Shanghai Mart 2299 Yanan Rd.
West Shanghai 200336 P.R.C.
Telephone: 86-21-6236-0322
Fax: 86-21-6236-1292